

**ASSEMBLY INSTRUCTIONS WARDROBE LUKAS  
MONTAGEBESCHRIJVING KAST LUKAS  
INSTRUCTIONS DE MONTAGE GARDEROBE LUKAS**

31-2015

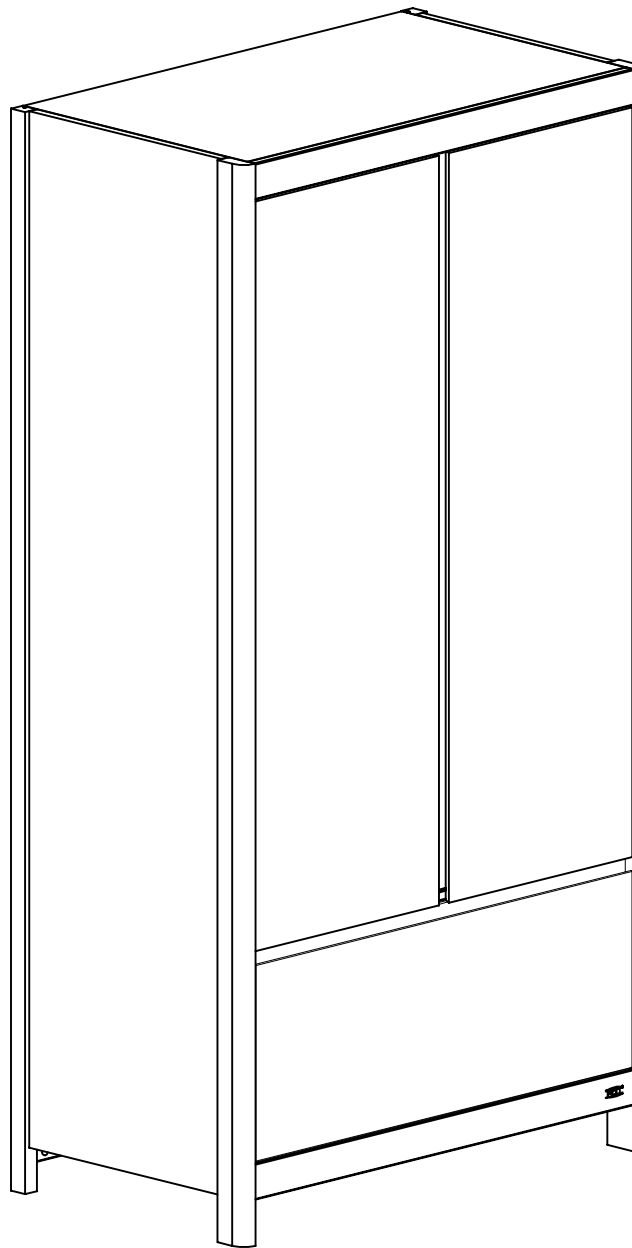

---

Imported by:  
Mikael Falk  
Pachthofstraat 41,  
B-3080 Tervuren

# PARTS LIST

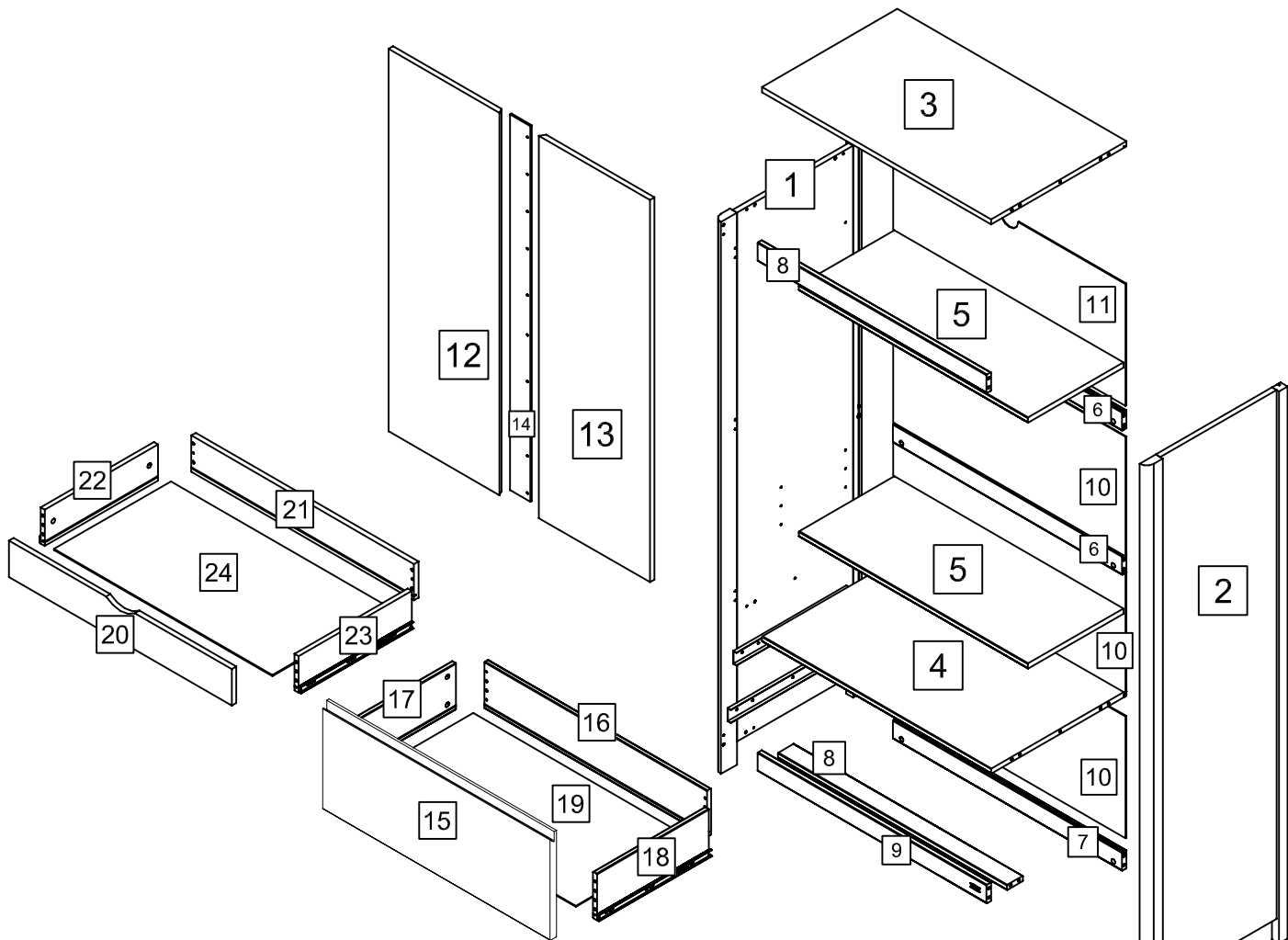

1 = 1	4 = 1	7 = 1	10 = 3	13 = 1	16 = 1	19 = 1	22 = 1
2 = 1	5 = 2	8 = 2	11 = 1	14 = 1	17 = 1	20 = 1	23 = 1
3 = 1	6 = 2	9 = 1	12 = 1	15 = 1	18 = 1	21 = 1	24 = 1

A x 30

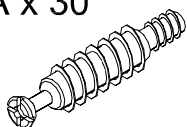

E x 6

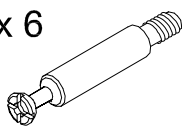

J x 1



N x 1



B x 36

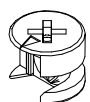

F x 1

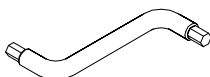

K x 2

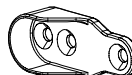

L x 6

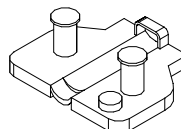

C x 36  
30 mm

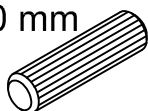

G x 8



M x 6

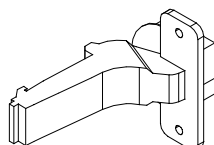

D x 26

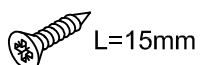



H x 16

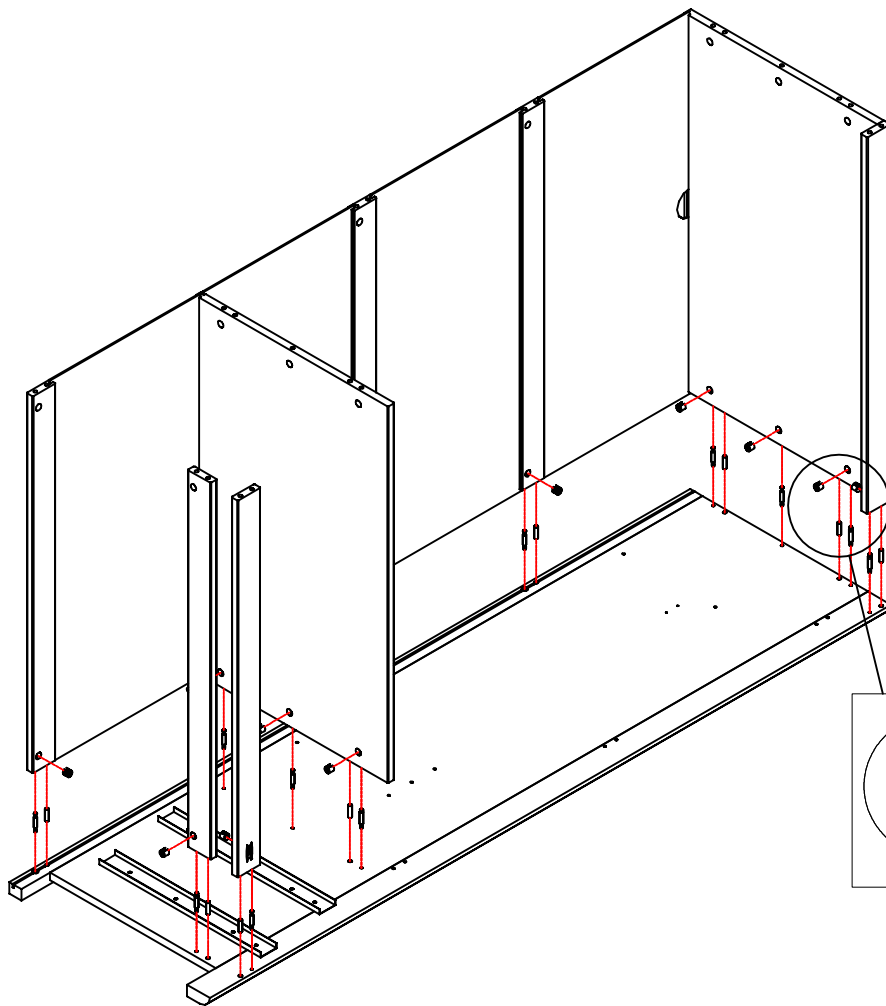

**TROLL**  
TURSNOV

1

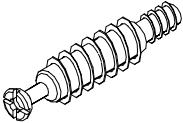
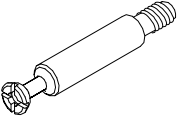
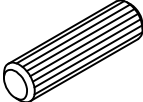

- B x 12 
- A x 9 
- E x 3 
- C x 10 

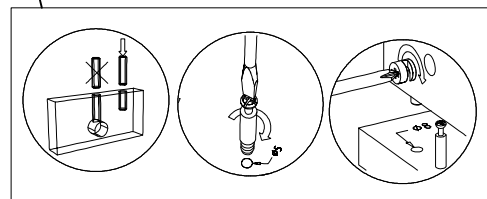

2

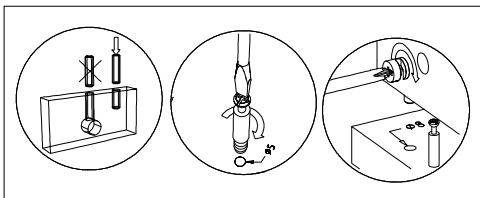

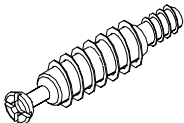
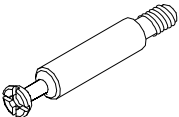
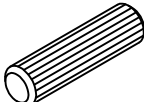
- B x 12 
- A x 9 
- E x 3 
- C x 10 

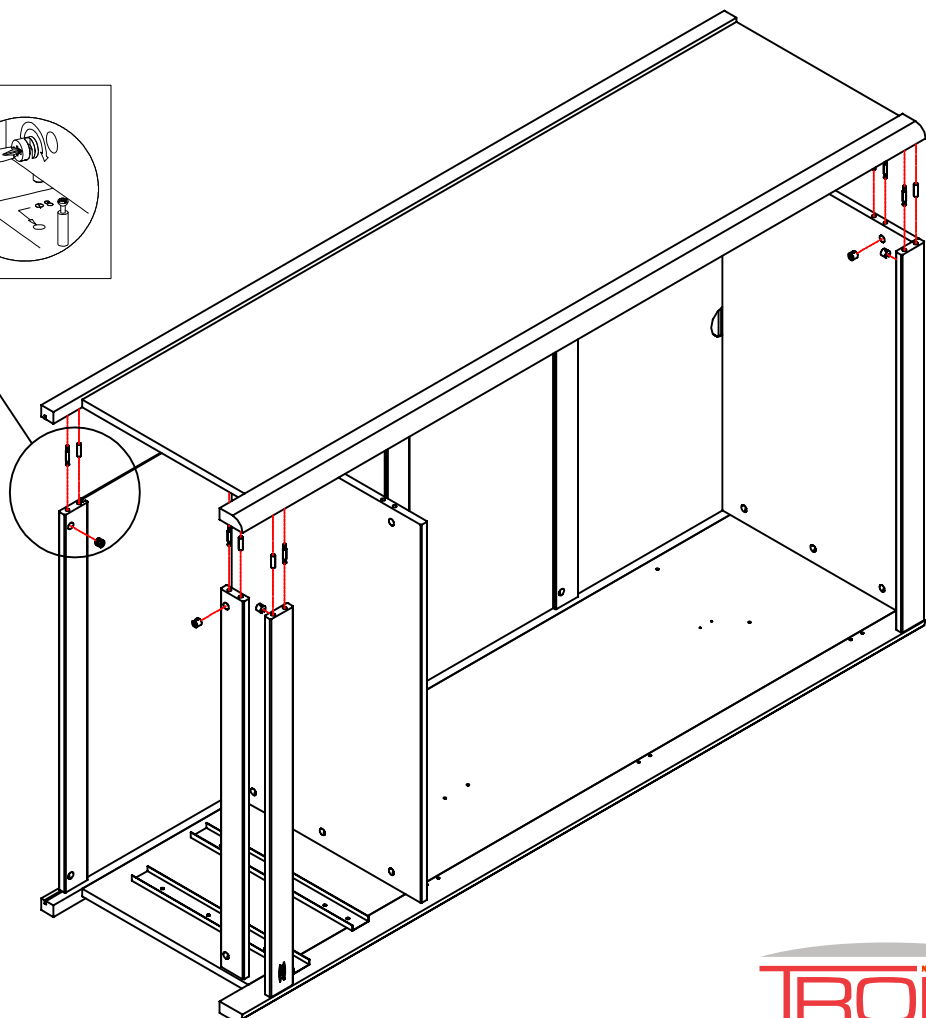

3

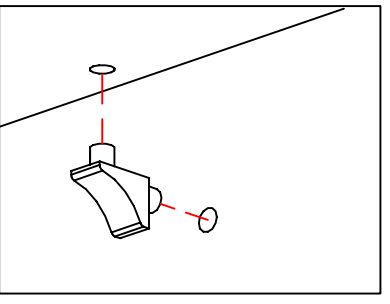
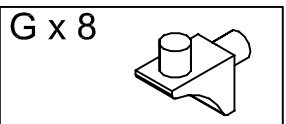
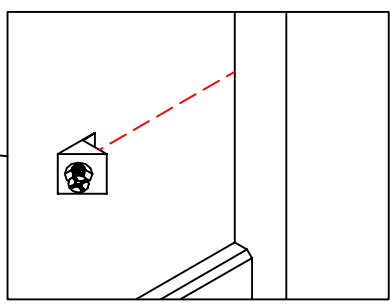
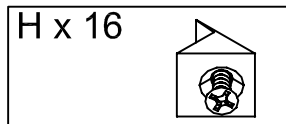
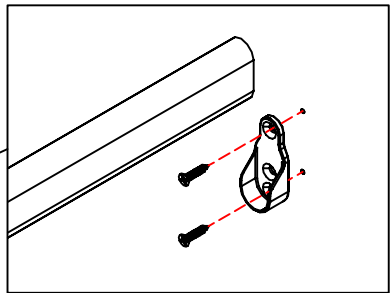
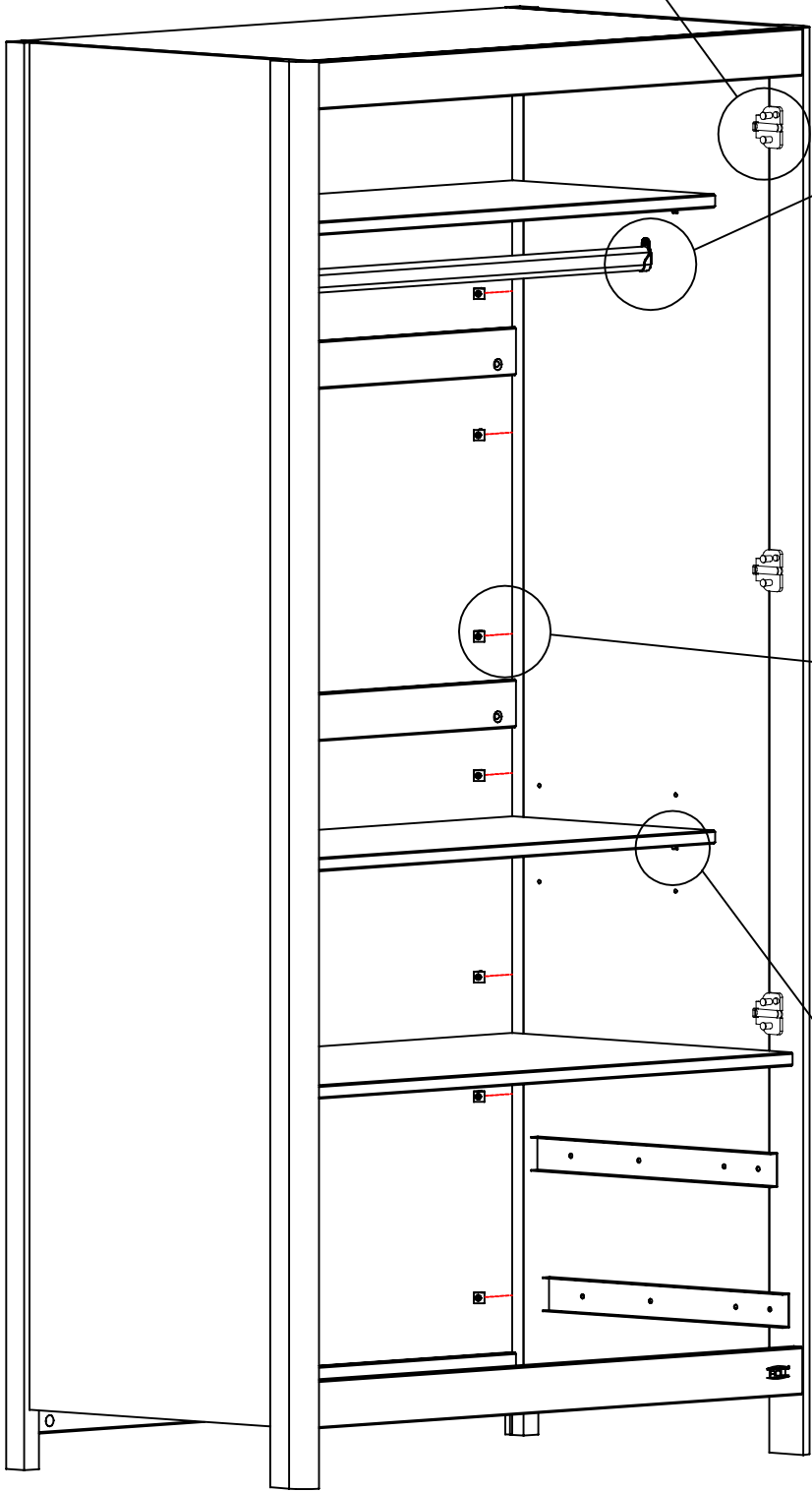
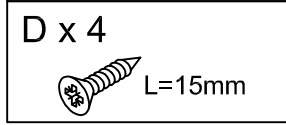
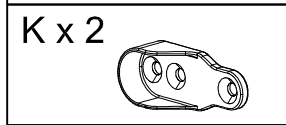
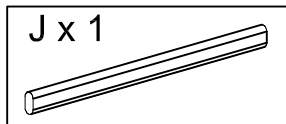
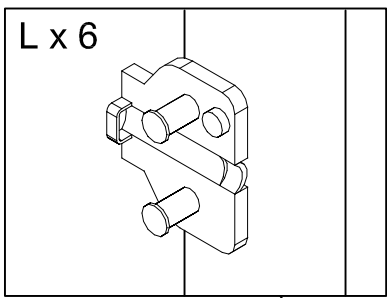

4

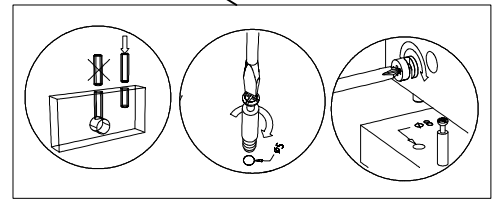
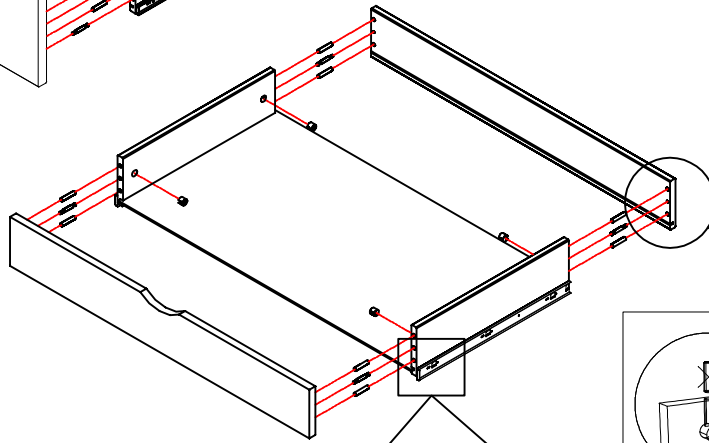
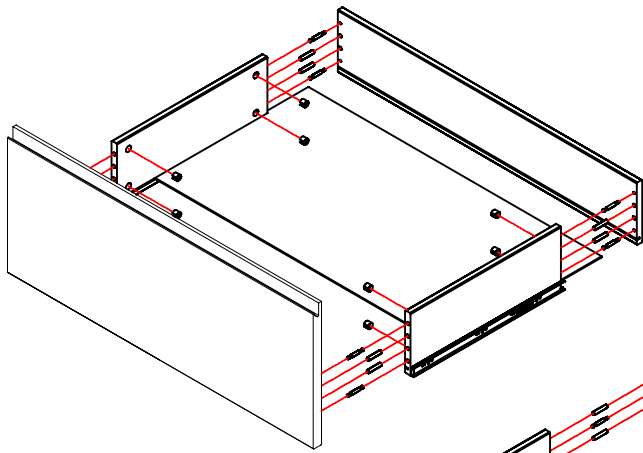

A x 12

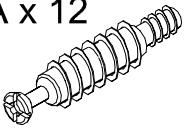

B x 12

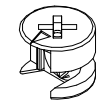

C x 16

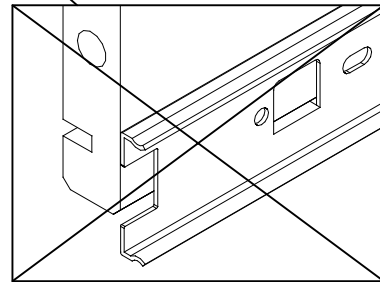
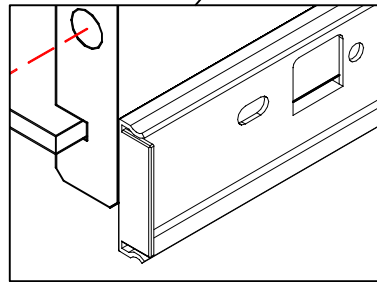
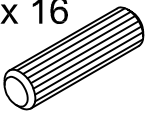

5

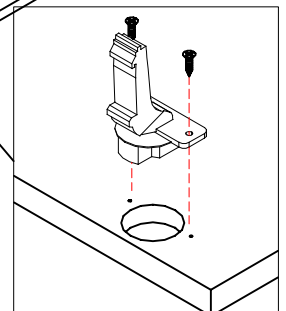
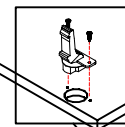
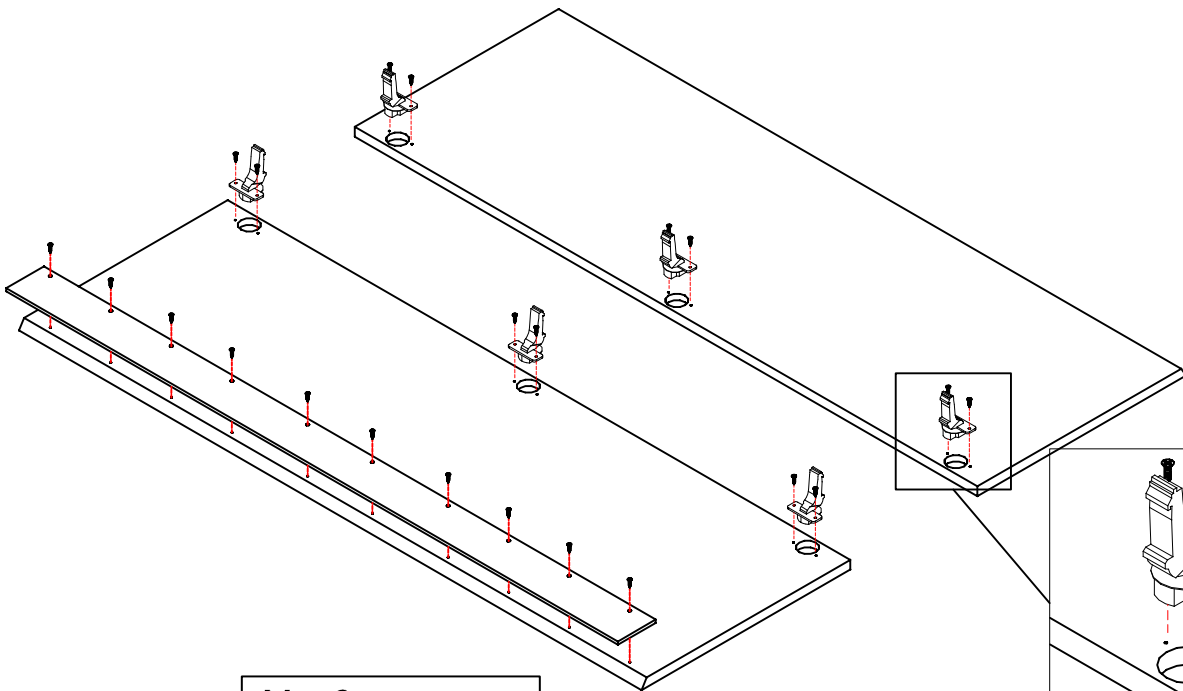

D x 22



L=15mm

M x 6

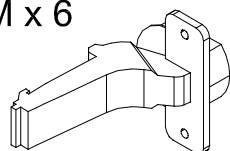

**TROLL**  
TURSKO

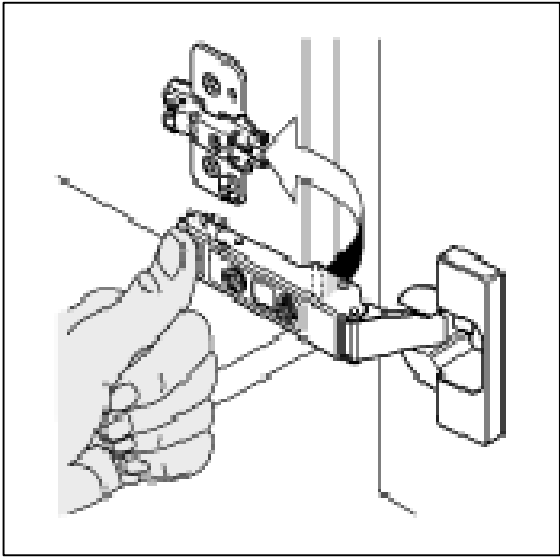

Side to side adjustment

In & out adjustment



Up & down adjustment

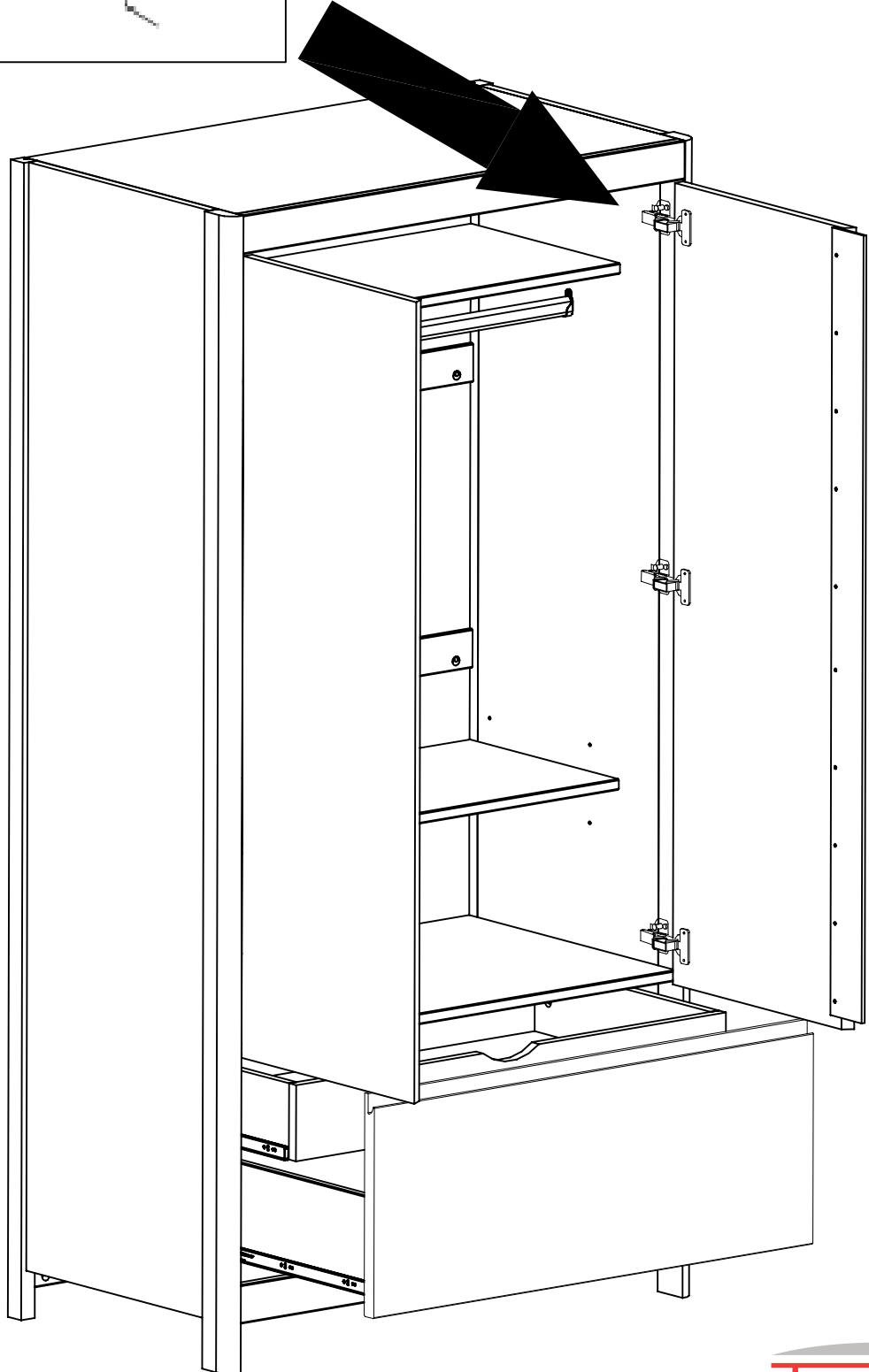

Wall attachment instructions  
Instructies voor muurbevestiging  
Instructions pour ancrage mural

## 1.

- First place in position. Mark position of centre top on wall.
- Plaats de kast waar ze zal komen te staan.  
Markeer op de muur waar het midden van het bovenblad komt.
- Placez le meuble à l'emplacement choisi.  
Marquez sur le mur l'endroit où viendra le centre de la tablette de l'armoire.

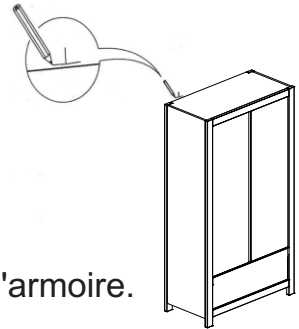

## 2.

- Attach fixing strap supplied to position on wall as shown. Ensure correct screws and fittings as appropriate to the type of wall are used. Check the wall is suitable for attaching this furniture.
- Monteer de bijgeleverde bevestigingsband op de wand zoals aangeduid. Controleer of de wand geschikt is om er het meubel aan te bevestigen. Gebruik schroeven en toebehoren die geschikt zijn voor het type wand.
- Apposez la bande d'ancrage au mur tel indiqué. Contrôlez si le mur ne pose pas problème pour l'apposition du meuble. Utilisez des vis et des accessoires appropriés au type de mur.

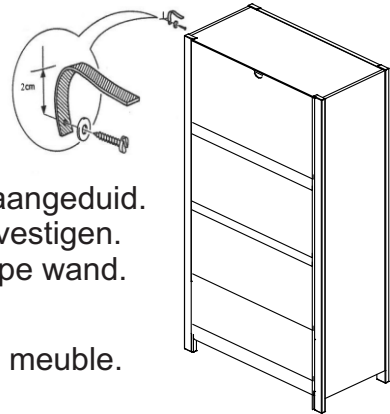

## 3.

- Using the wood screw and washer supplied attach fixing strap to the underside of top panel.
- Monteer de bijgeleverde bevestigingsband aan de onderkant van het meubelblad met de houtvijs en het ringetje.
- Montez la bande d'ancrage fournie au dessous de la tablette de l'armoire au moyen de la vis à bois et de la rondelle.

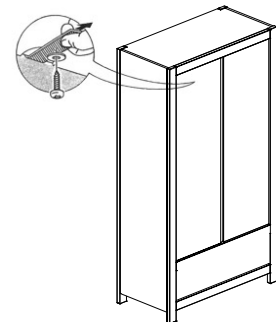

### **Warning:**

Ensure strap is attached securely at both ends to avoid danger of furniture tipping forwards. This installation should only be carried out by a competent person. Incorrect installation could present a danger. Check the wall is suitable for attachment and will withstand the forces generated by furniture tipping forward.

### **Waarschuwing**

Controleer of de bevestigingsband aan beide uiteinden stevig vastgemaakt is, dit om te vermijden dat het meubelstuk voorover zou vallen. De montage en muurbevestiging moeten door een bekwaam persoon uitgevoerd worden. Een gebrekkige installatie houdt gevaar in. Controleer of de wand geschikt is om er het meubel aan te bevestigen en weerstand genoeg kan bieden mocht het meubel voorover vallen.

### **Avertissement**

Contrôlez si la bande d'ancrage est solidement amarrée aux deux extrémités, ceci afin d'éviter que le meuble ne se renverse. Afin d'éviter tout danger, la fixation et l'ancrage doivent être exécutés par une personne compétente. Contrôlez si le mur ne pose pas problème pour l'apposition du meuble et sera suffisamment résistant au cas où le meuble se renverserait.