

Assembly instructions GROOVY wardrobe 2014
Montagebeschrijving kast GROOVY 2014
Instructions de montage garde-robe GROOVY 2014

27.06.2014

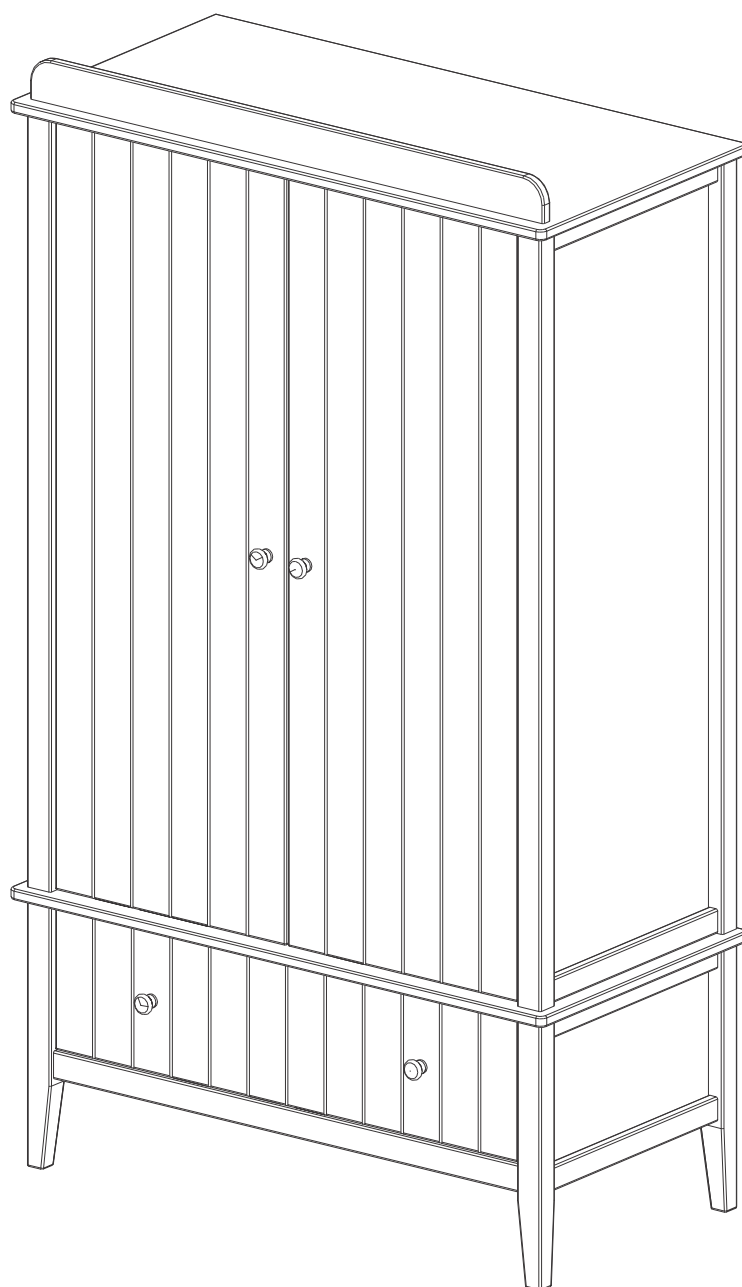

Imported by:
Mikael Falk
Pachthofstraat 41,
B-3080 Tervuren

BEFORE YOU START

Remove all parts from packaging and check against the parts list.

Do not discard any packaging until you are sure you have all parts and the pack of fittings.

SAFETY INSTRUCTION

Ensure that screws, packaging etc are discarded safely and kept away from children.

Keep children at a safe distance when assembling.

Do not use if any part is broken or missing.

Do not use on an uneven surface.

Ensure that the wardrobe is kept away from strong heat sources such as an electrical bar, gas and open fires.

Care should be taken that no screws or other fittings are loose so your child can trap parts of the body or clothing.

Check regularly to ensure that all the components are secure.

Do not use if any part is broken.

Store in a dry ventilated place when not in use.

Only parts supplied by Troll Nursery should be used.

The correct use and maintenance of you wardrobe will ensure it gives long and trouble free use. When somebody is using your wardrobe, ensure they also know how to use it.

The safety of your child is your responsibility.

CARE AND MAINTENANCE INSTRUCTIONS

Your furniture may be cleaned by wiping with a damp cloth and drying with a soft clean cloth.

Do not use abrasives, bleach, alcohol or ammonia-based household polishes.

Take care when handling or moving the furniture. Careless handling may cause damage.

CUSTOMER ENQUIRIES

www.troll.lv



PARTS LIST

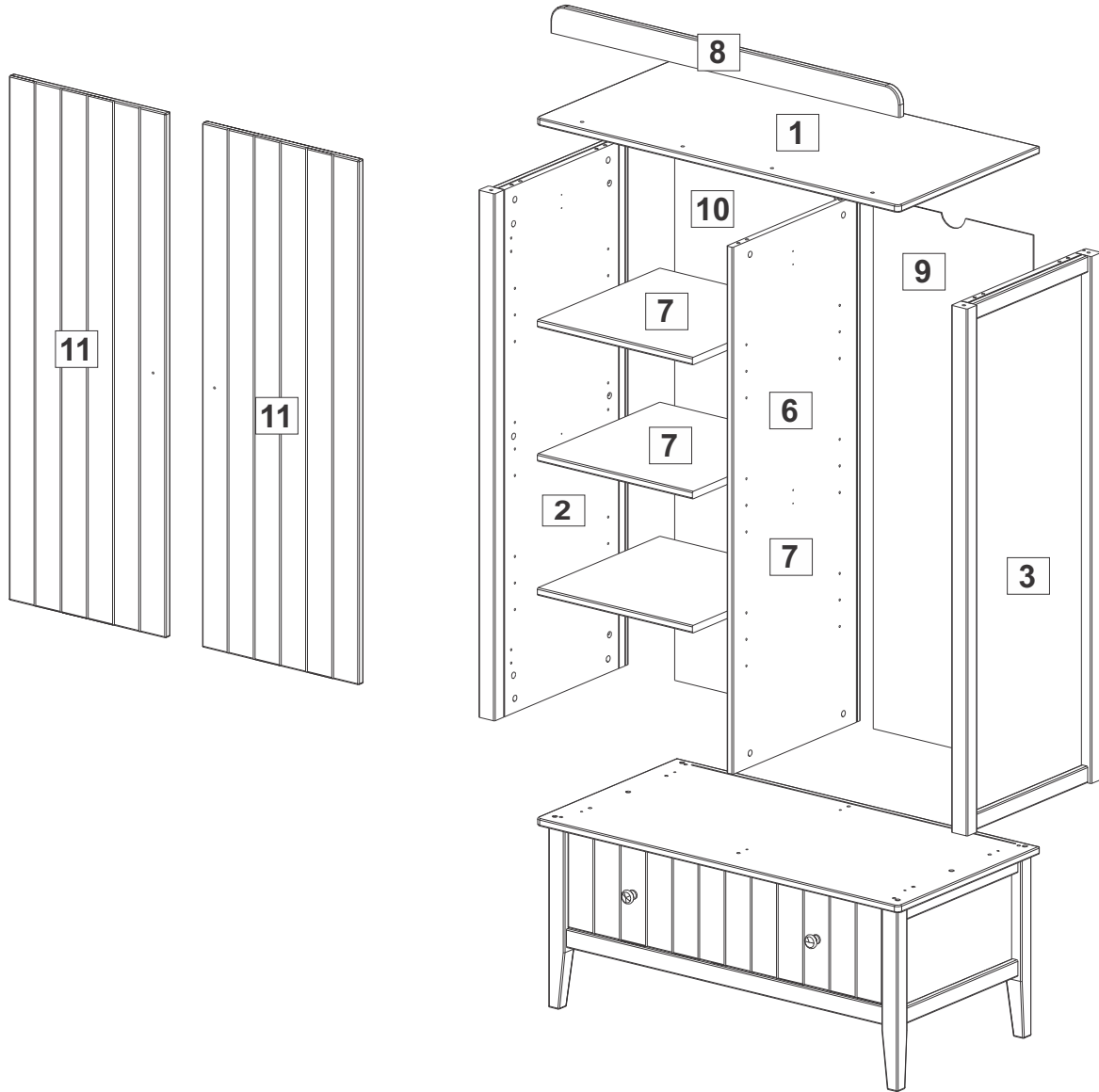

FITTINGS

A x 12

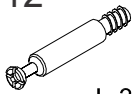

L=34mm

B x 12



Ø15mm

C x 24

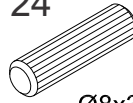

Ø8x30mm

D x 4



L=40mm

E x 10

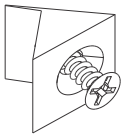

K x 4

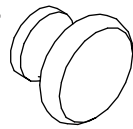

G x 12



M x 4

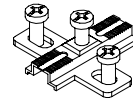

S x 1

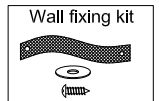

N x 4

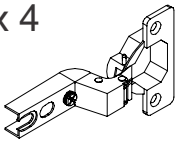

O x 16



L=15mm

P x 4

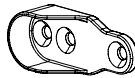

R x 2

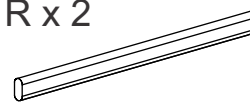

TOOLS

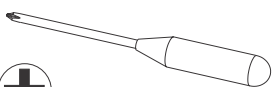

ASSEMBLY

1

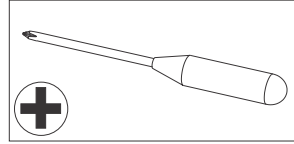

A x 20

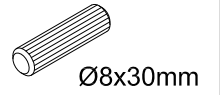

B x 12

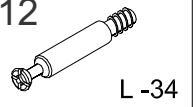

C x 12

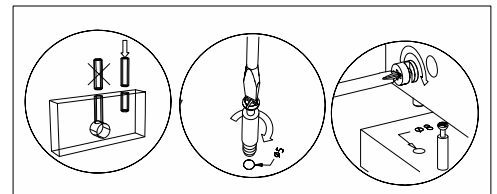
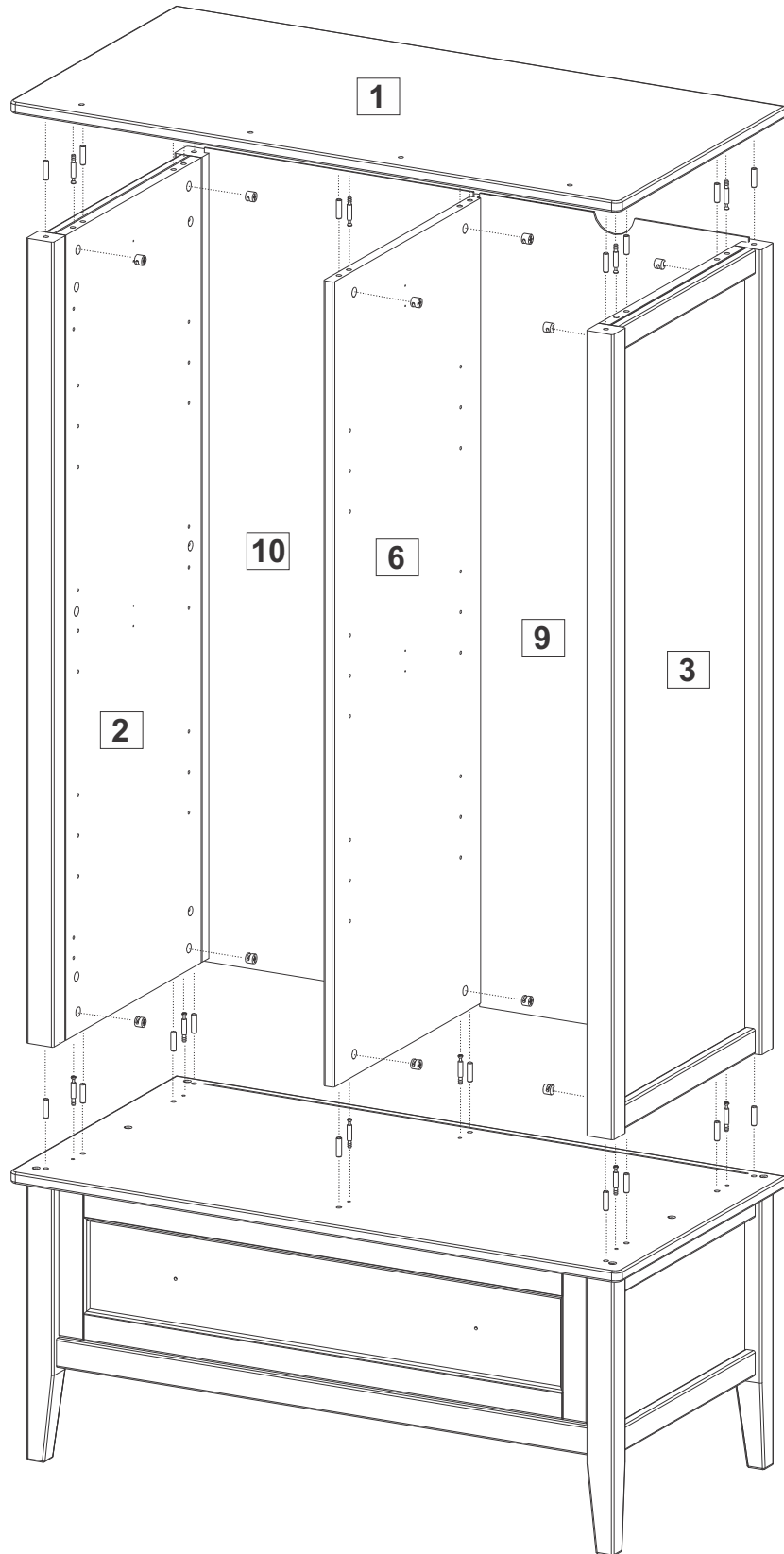

ASSEMBLY

2

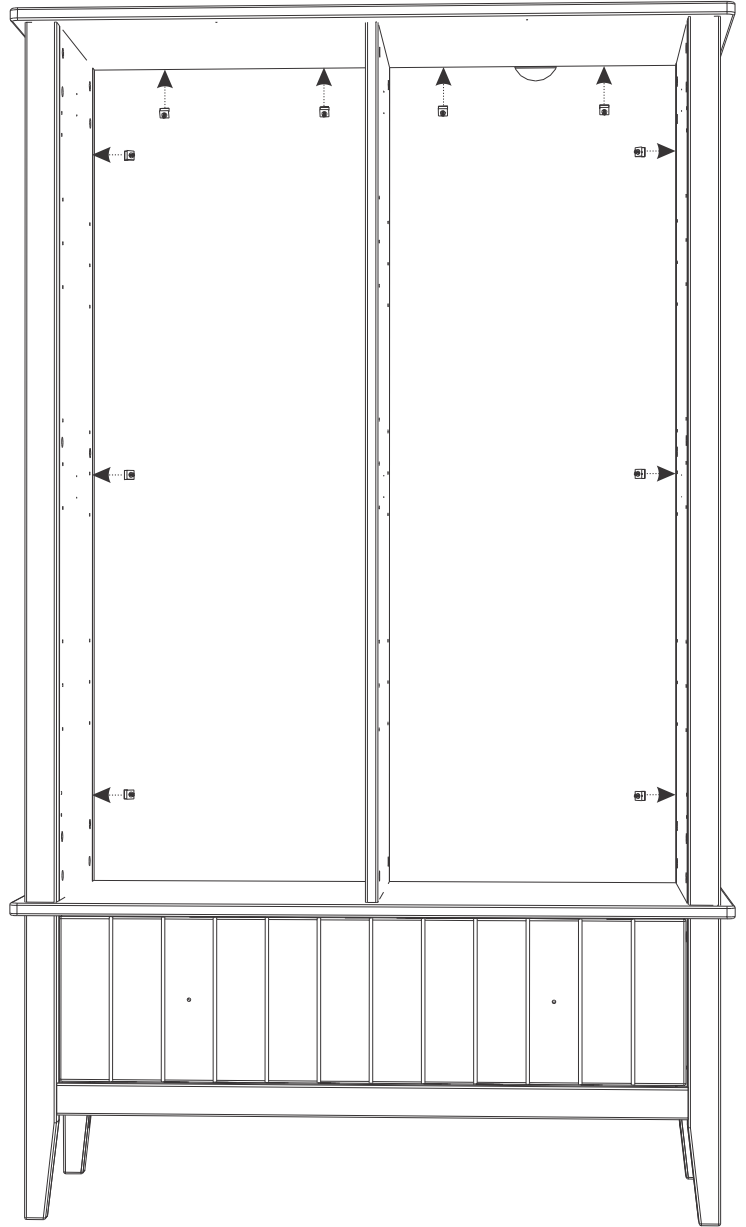
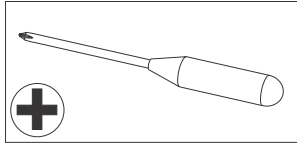

E x 10

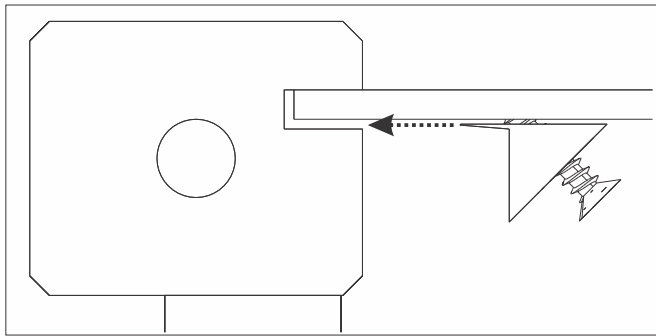
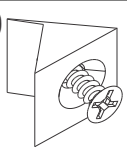

3

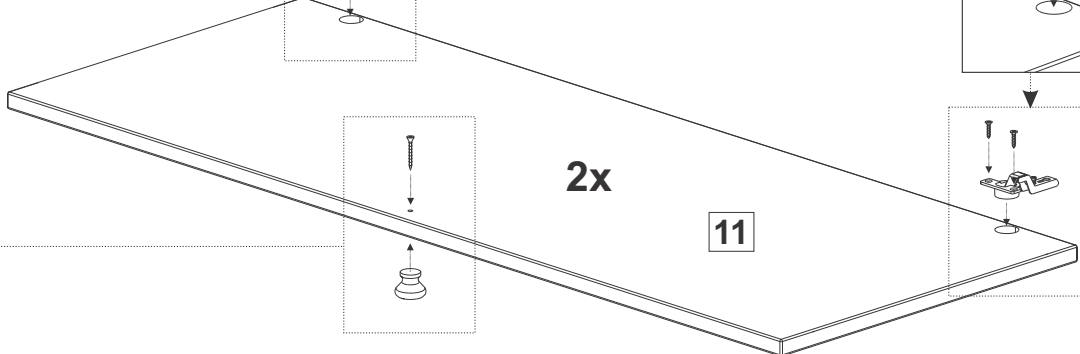
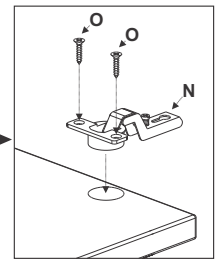
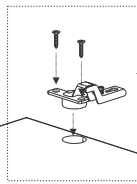
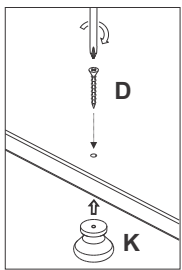
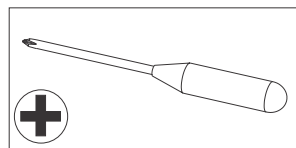

K x 2

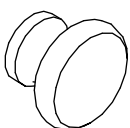

D x 2

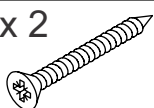

L=40mm

O x 8



L=15mm

N x 4

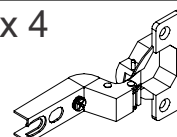

TROLL

ASSEMBLY

4

O x 8



L=15mm

G x 12



M x 4

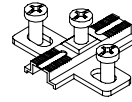

P x 4

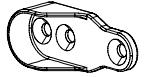

R x 2

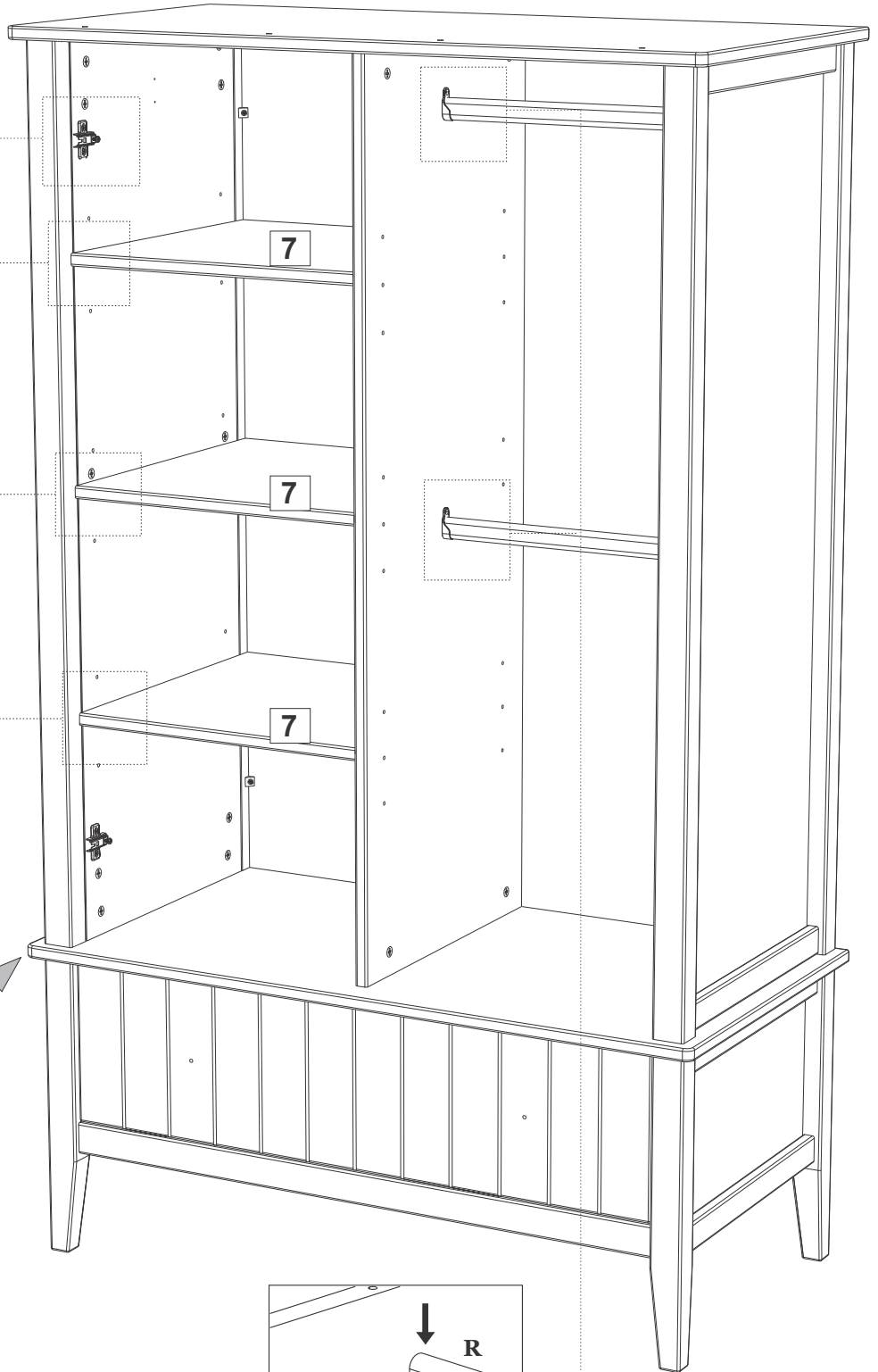
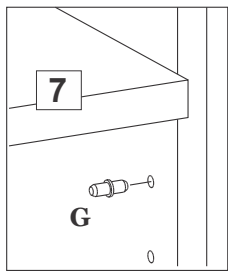
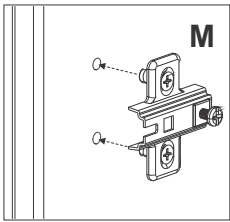
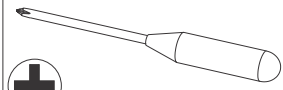

OR

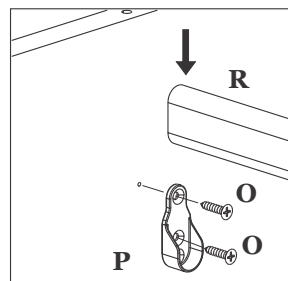
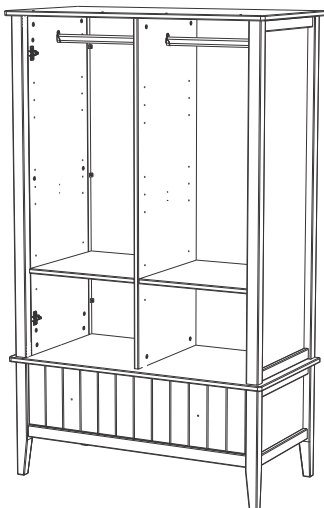

TROLL

ASSEMBLY

6

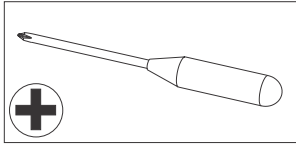

A x 4

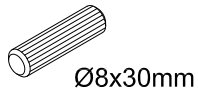

K x 2

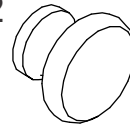

Q x 2

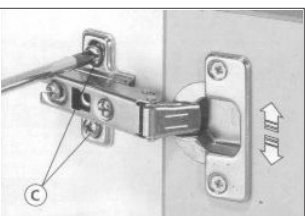
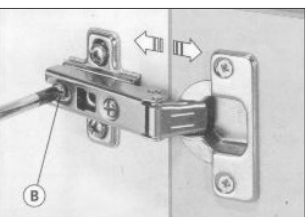
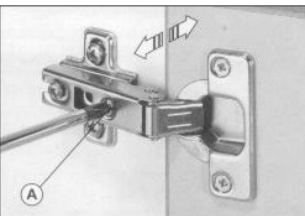
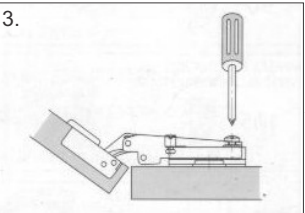
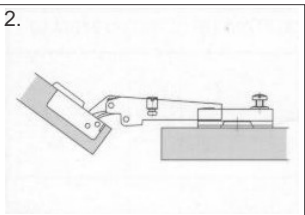
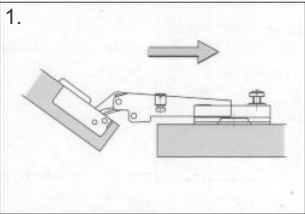
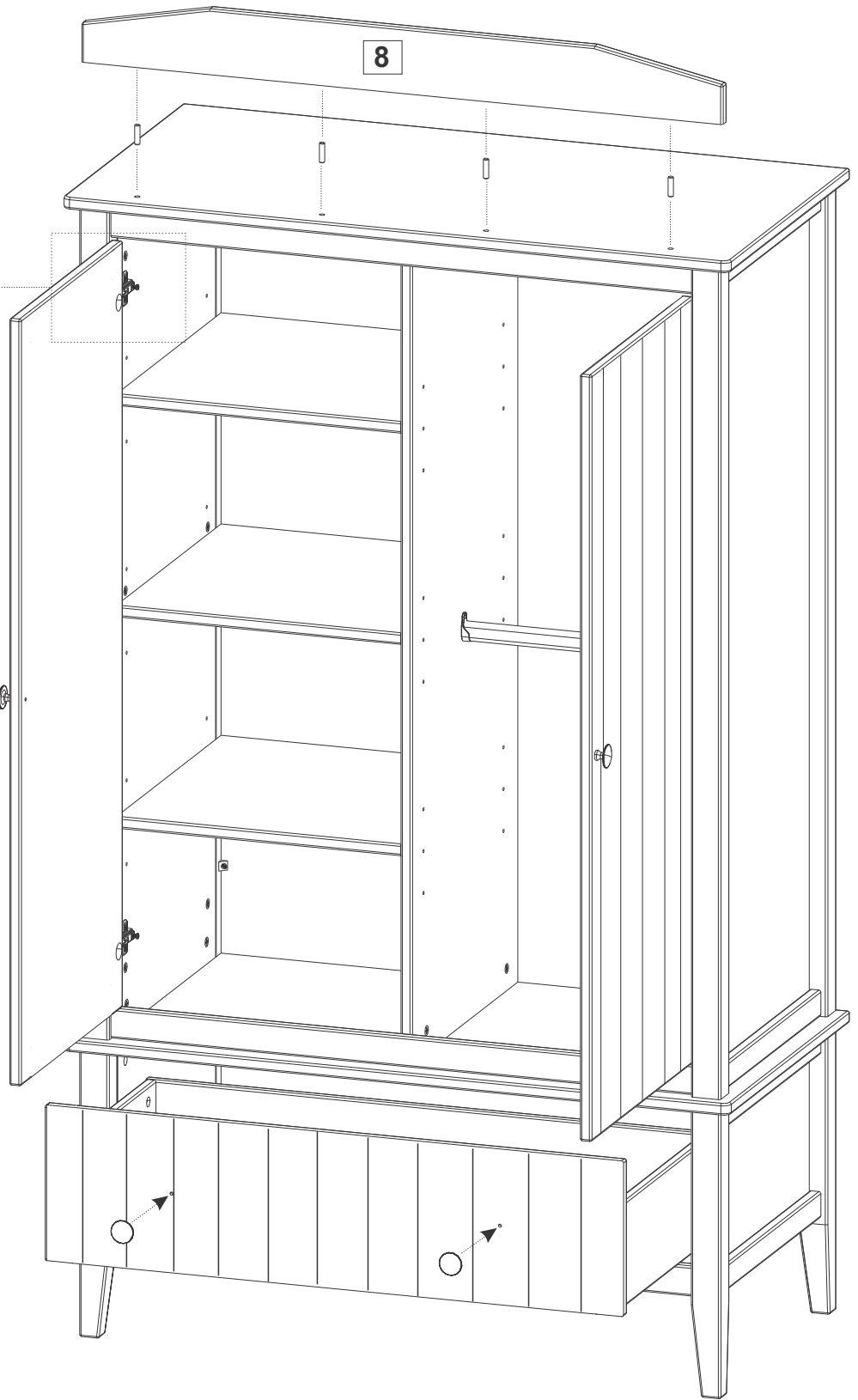
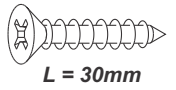

Wall attachment instructions

Instructies voor muurbevestiging

Instructions pour ancrage mural

1.

- First place in position. Mark position of centre top on wall.
- Plaats de kast waar ze zal komen te staan.
Markeer op de muur waar het midden van het bovenblad komt.
- Placez le meuble à l'emplacement choisi.
Marquez sur le mur l'endroit où viendra le centre de la tablette de l'armoire.

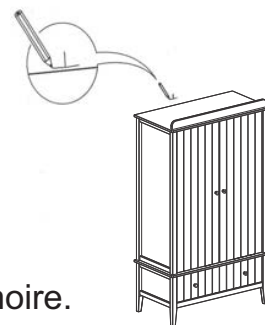

2.

- Attach fixing strap supplied to position on wall as shown. Ensure correct screws and fittings as appropriate to the type of wall are used. Check the wall is suitable for attaching this furniture.
- Monteer de bijgeleverde bevestigingsband op de wand zoals aangeduid. Controleer of de wand geschikt is om er het meubel aan te bevestigen. Gebruik schroeven en toebehoren die geschikt zijn voor het type wand.
- Apposez la bande d'ancrage au mur tel indiqué. Contrôlez si le mur ne pose pas problème pour l'apposition du meuble. Utilisez des vis et des accessoires appropriés au type de mur.

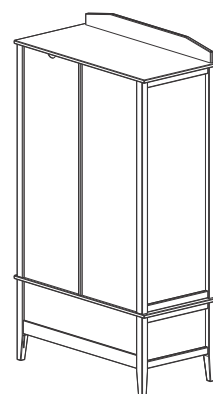
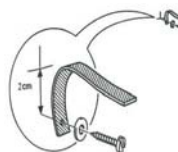

3.

- Using the wood screw and washer supplied attach fixing strap to the underside of top panel.
- Monteer de bijgeleverde bevestigingsband aan de onderkant van het meubelblad met de houtvijs en het ringetje.
- Montez la bande d'ancrage fournie au dessous de la tablette de l'armoire au moyen de la vis à bois et de la rondelle.

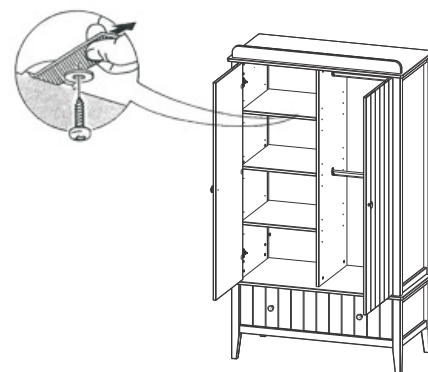

Warning:

Ensure strap is attached securely at both ends to avoid danger of furniture tipping forwards. This installation should only be carried out by a competent person. Incorrect installation could present a danger. Check the wall is suitable for attachment and will withstand the forces generated by furniture tipping forward.

Waarschuwing

Controleer of de bevestigingsband aan beide uiteinden stevig vastgemaakt is, dit om te vermijden dat het meubelstuk voorover zou vallen. De montage en muurbevestiging moeten door een bekwaam persoon uitgevoerd worden. Een gebrekkige installatie houdt gevaar in. Controleer of de wand geschikt is om er het meubel aan te bevestigen en weerstand genoeg kan bieden mocht het meubel voorover vallen.

Avertissement

Contrôlez si la bande d'ancrage est solidement amarrée aux deux extrémités, ceci afin d'éviter que le meuble ne se renverse. Afin d'éviter tout danger, la fixation et l'ancrage doivent être exécutés par une personne compétente. Contrôlez si le mur ne pose pas problème pour l'apposition du meuble et sera suffisamment résistant au cas où le meuble se renverserait.