



ASSEMBLY INSTRUCTIONS

WARDROBE



PARTS LIST

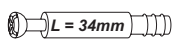
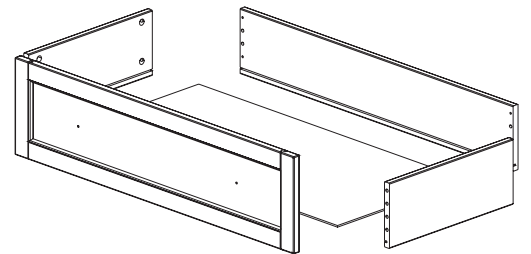
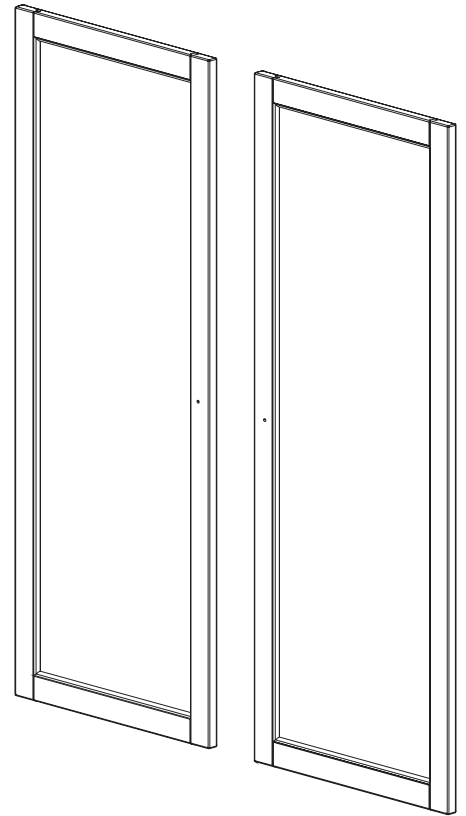
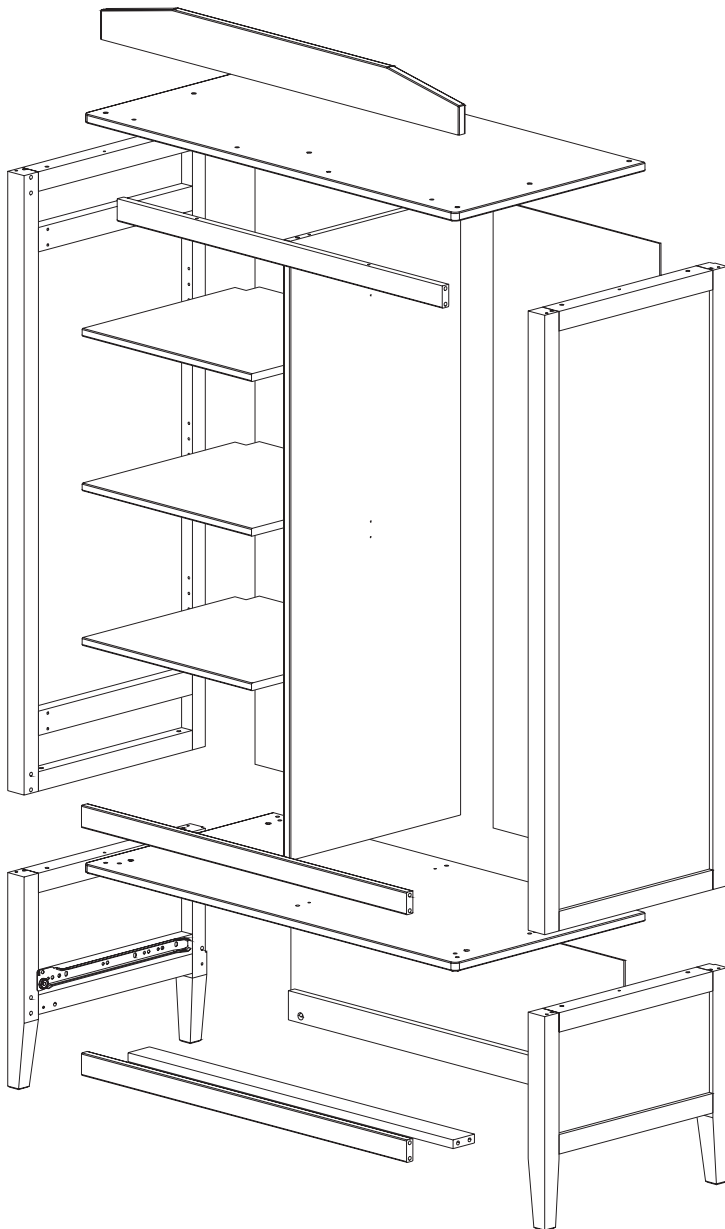

A x 14



B x 14

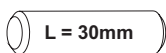

C x 48

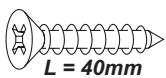

D x 6

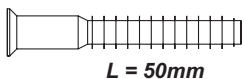

E x 14

L = 50mm



F x 1

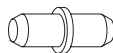

G x 12



I x 11

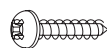

J x 43



K x 4



L x 4

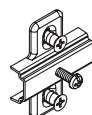

M x 4



N x 4

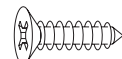

O x 16

L = 15mm



P x 4

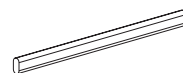

R x 2

ASSEMBLED

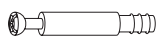

A=4



C=8



B=4

1.

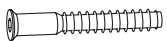
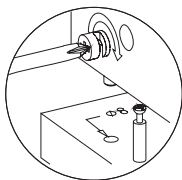
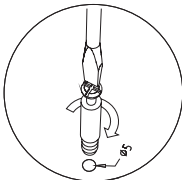
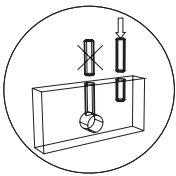
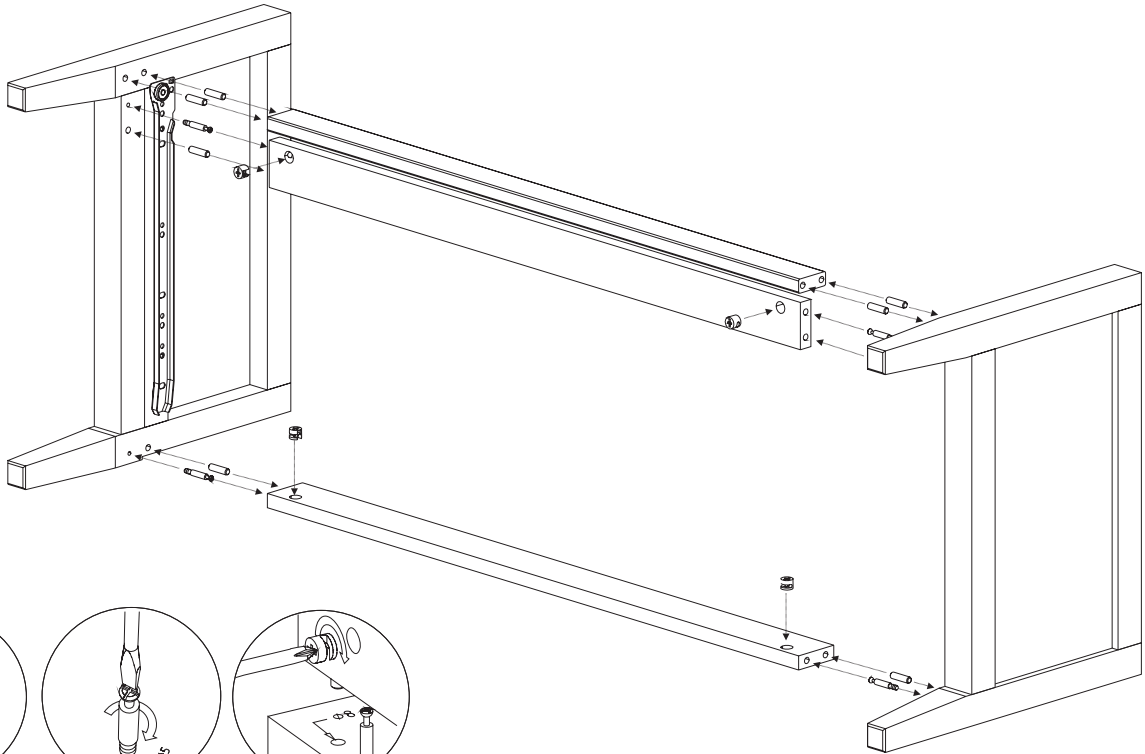

E x 6

L = 50mm



C=4



F

2.

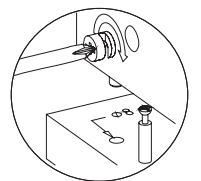
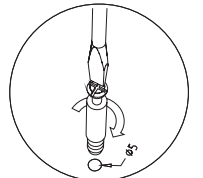
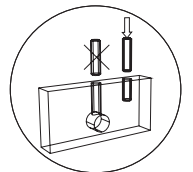
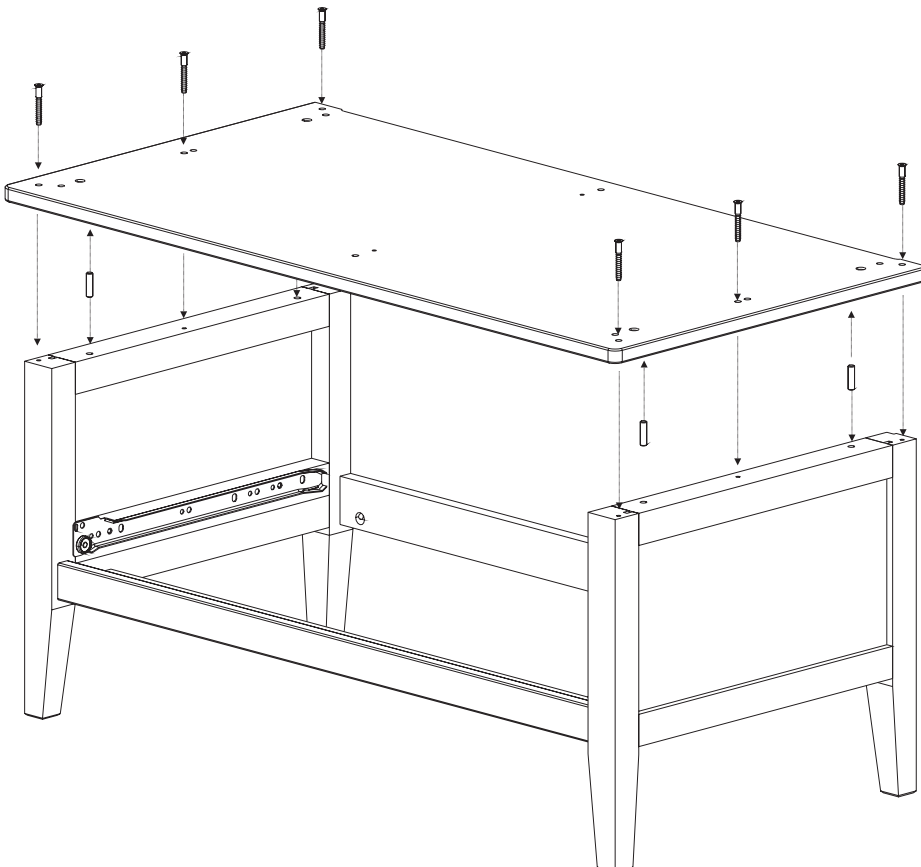

ASSEMBLED

3.

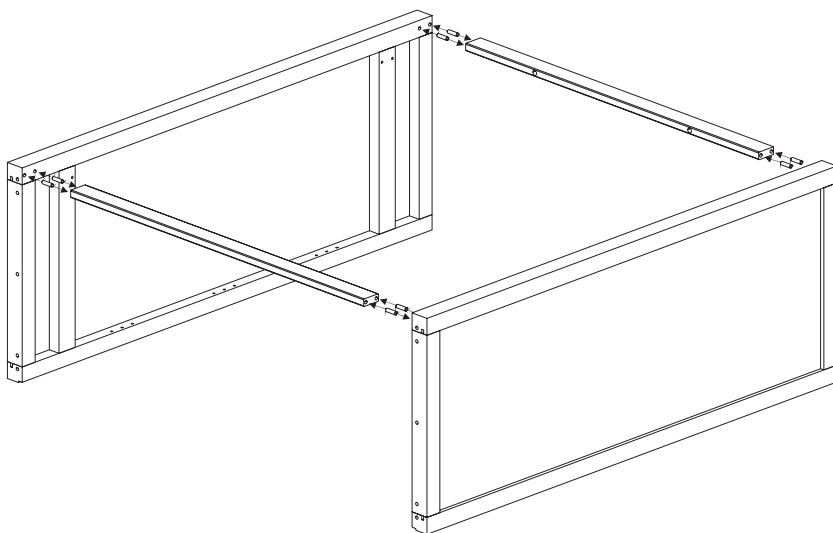

4.

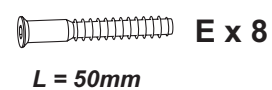
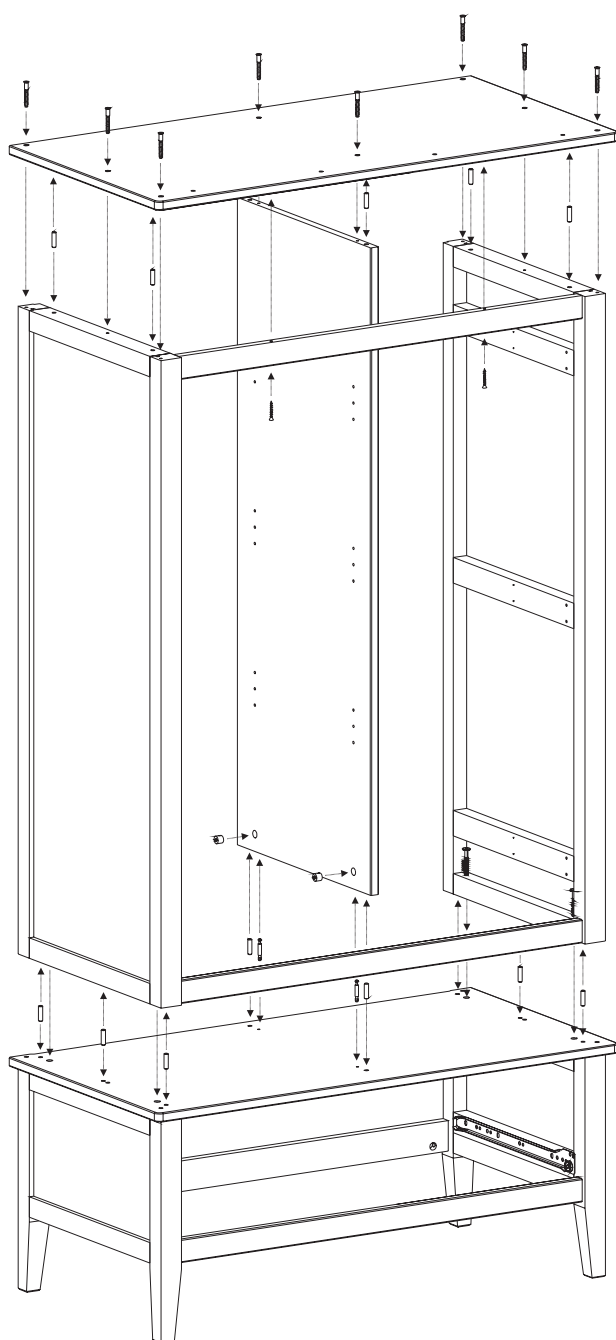

ASSEMBLED

5.

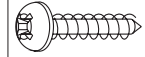
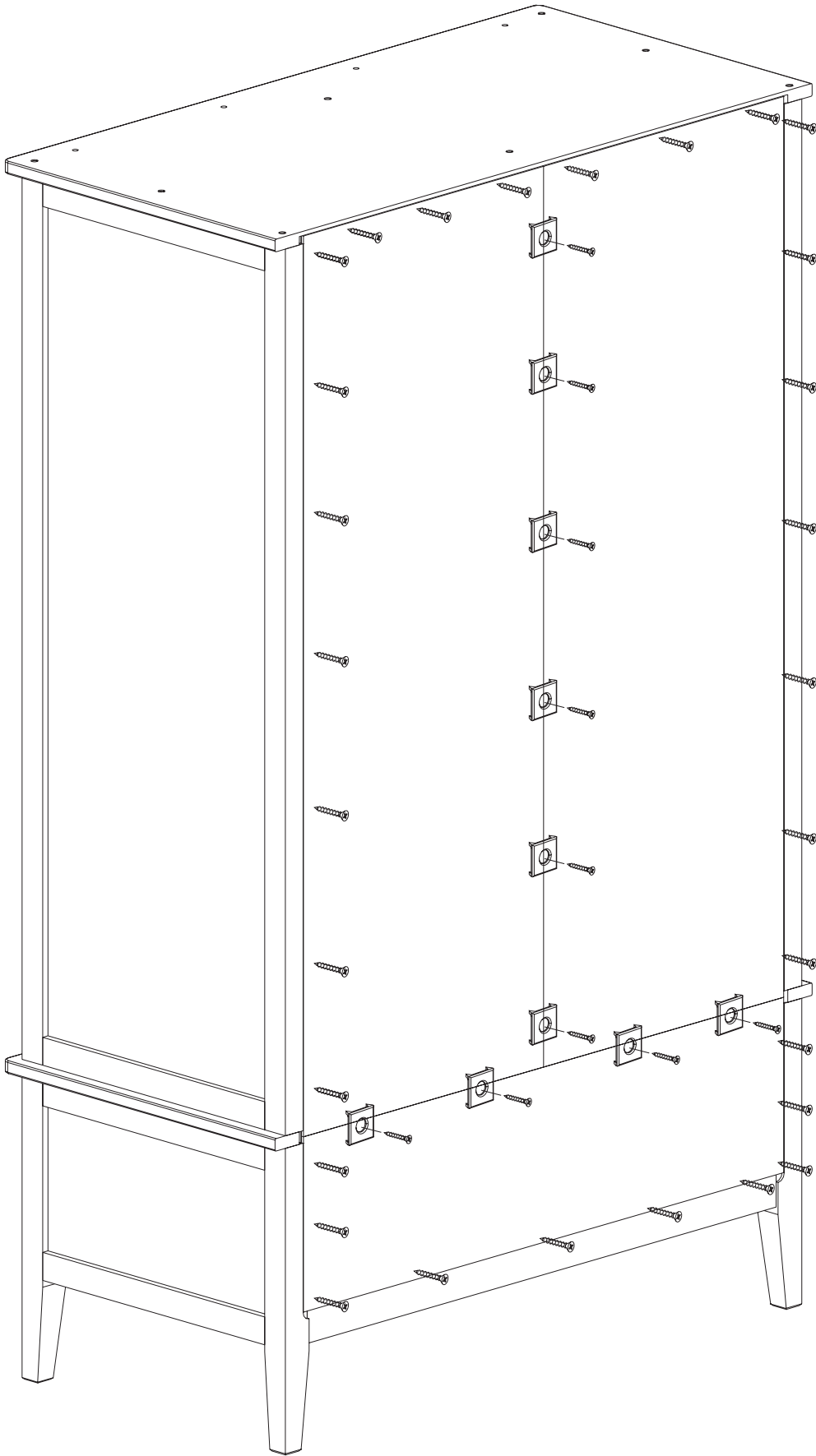

J=25

L = 20mm



I=5

ASSEMBLED

6.

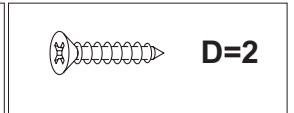
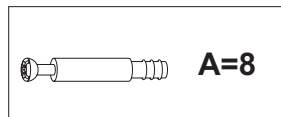
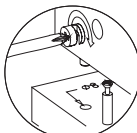
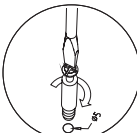
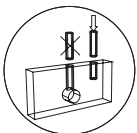
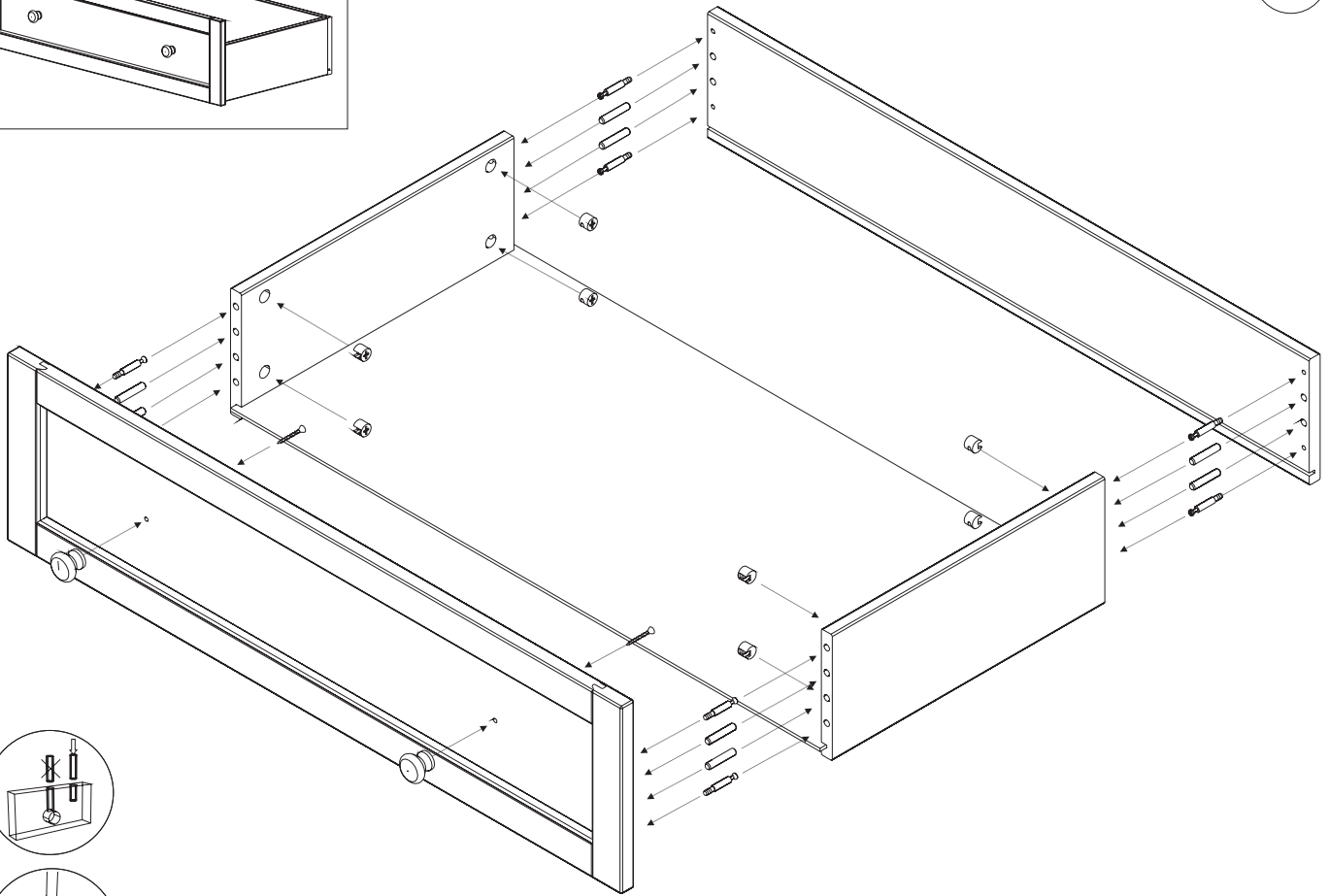
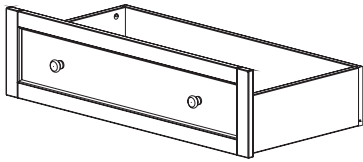

7.

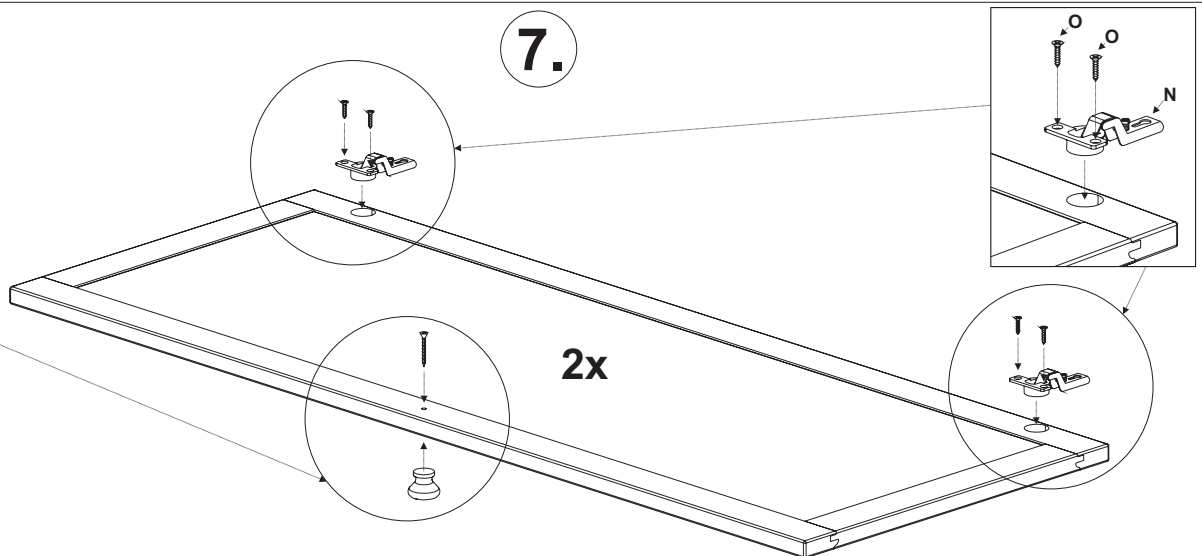
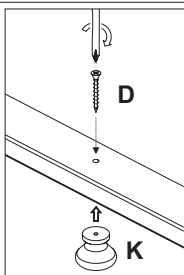

2x

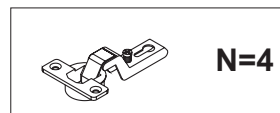
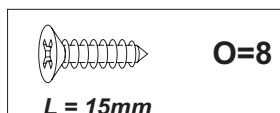
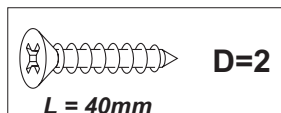
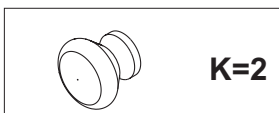

ASSEMBLED

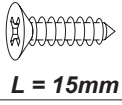

O=8

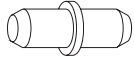

G=12

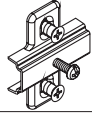

M=4

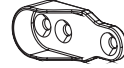

P x 4

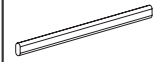

R x 2

8.

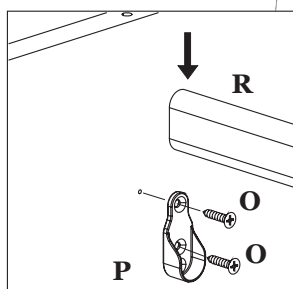
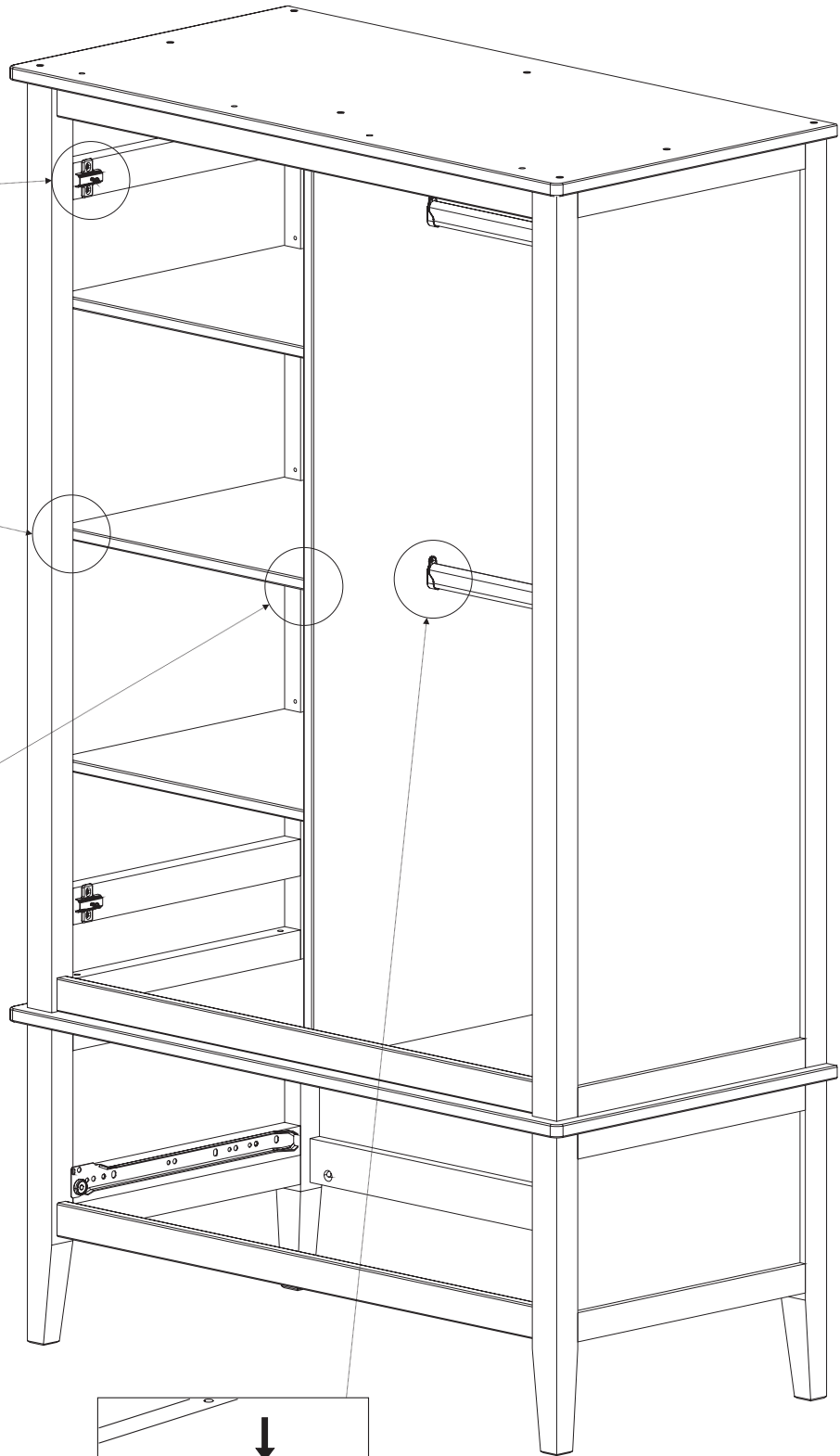
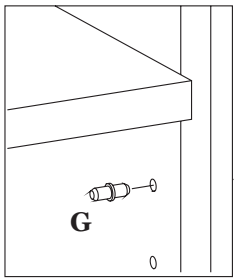
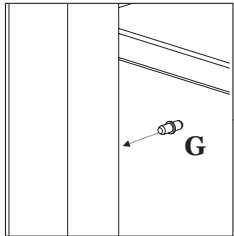
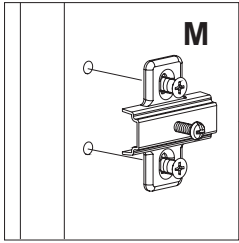

ASSEMBLED

9.



C=4

ASSEMBLED

$X = Y$ OK.

10

$X \neq Y$

